

Spray Guns (SG)

Our spray guns are constructed of virgin PTFE and Polypropylene to provide them with a long life span in harsh acidic or corrosive environments. Due to their design and comfortable grip Spray Guns are quickly becoming the industry standard in semiconductor fab plants, wet benches and work processing stations. All the Spray Guns may be purchased individually or with a variety of fittings and hoses.

Recirculating Spray Guns (RC)

The Recirculating Spray Guns all have molded PTFE bodies with PVDF pistons. These RC Guns are designed so that there is very little dead space for bacteria to grow. DI water is able to circulate up to the sealing seat throughout the entire gun and piston. From the sealing seat on, bacteria build up is kept to a minimum by using a 1/16" thick spray nozzle.

Nitrogen Guns (Nitro)

Our PTFE Nitrogen Guns (Nitro) can deliver maximum anti-corrosion protection wherever extreme chemical environments are used in the vicinity of nitrogen dispensing or dying. Like its companion, the DI Water Spray Gun, Nitro is manufactured of the same durable materials to resist acid attacks.



Dispense Guns (DG)

Both of the dispense guns, standard or high flow, are designed with the spring totally isolated from the media, thus making them the perfect choice for dispensing acids and solvents. The longer nozzle on the dispense guns allows for them to be inserted into a container thus minimizing splashing.

Eye Wash (EW)

PTFE Eye Wash is designed to provide emergency eye/ facial rinse. When activated a soft flow of aerated water is released. The non-metallic aerator converts harsh city water into a bubbly smooth stream while the PTFE body remains inert to its potentially hostile chemical environment.

DI SPRAY / RINSING GUNS

(Max. operating pressure 75 PSI)

(Media Temperature Range: 40°F – 130°F)

Part No.	Description
SG-103	Standard Spray Gun with 1/2" FNPT inlet thread. ⁽¹⁾
SG-102	Spray Gun with 3/8" FNPT inlet thread.
SG-101	Spray Gun with 1/4" FNPT inlet thread.

NOTE: ADD -FT FOR FRONT TRIGGER OPTION.
ADD -H FOR MOUNTING HOOK.

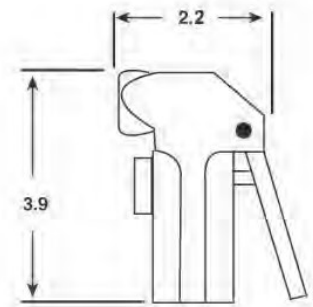

SG-101
SG-102
SG-103

Assemblies

Part No.	Gun	Hose	Intercon. Fitting	Source Fitting
SG-401	SG-101	C4-FEP	MC-F-44	MC-F-44
SG-402	SG-101	C4-PU	J44	J44
SG-403	SG-101	304	MC-F-44	MC-F-44
SG-601	SG-102	C6-FEP	MC-F-66	MC-F-66
SG-602	SG-102	C6-PU	J66	J66
SG-603	SG-102	306	MC-F-66	MC-F-66
SG-801	SG-103	C8-FEP	MC-F-88	MC-F-88
SG-802	SG-103	C8-PU	J88	J88
SG-803	SG-103	308	MC-F-88	MC-F-88

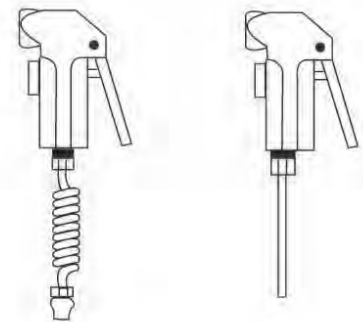

SG-X01
SG-X02

SG-X03



Special Nozzle Configurations Available

RECIRCULATING SPRAY GUNS

(Max. operating pressure 75 psi)

(Media Temperature Range: 40°F – 130°F)

Part No.	Description
RC-103	Recirculating spray gun with 1/2" FNPT inlet thread (gun only). ⁽¹⁾

Assemblies		
Part No.	Gun	Hose Assy.
RC-105	RC-103	RC-3 / RC-9

RC-106	RC-103	RC-5 / RC-9
--------	--------	-------------

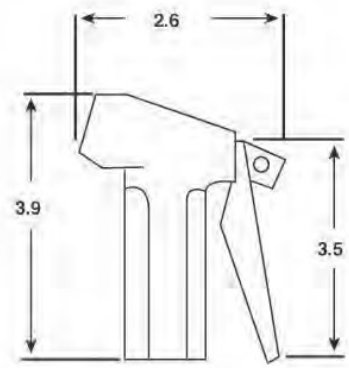

RC-103

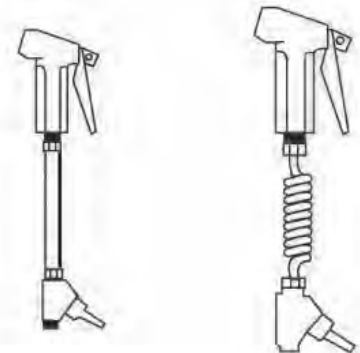

RC-105

RC-106

Recirculating Device:

iPolymer Recirculating Spray Guns (“RC” style) are designed to eliminate bacterial growth in DI water spray systems. When the spray gun is not in use, the DI water travels back down the parallel recirculation flow path and returns to the client DI recovery tank or drain line.

By eliminating stagnant pooling water, this open continuous recirculation path reduces bacterial growth.

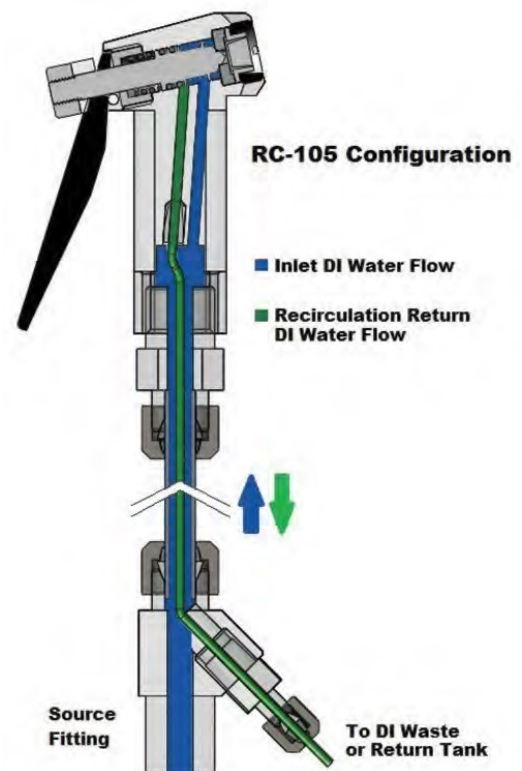

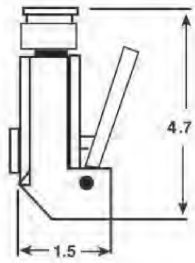

Nitro-1

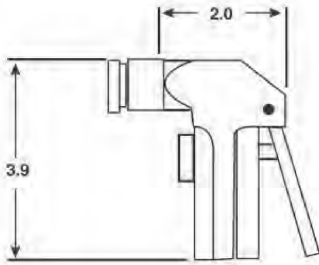

Nitro-2

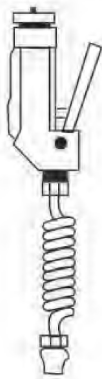

Nitro-3



Nitro-4

NITROGEN / DRYING GUNS ⁽³⁾

(Max. operating pressure 75 PSI) (Media Temperature Range: 40°F – 130°F)

Part No.	Description
Nitro-1	Standard nitrogen hand spray with 1/4" FNPT inlet thread, filter housing with disposable filter.
Nitro-2	Same as Nitro 1 only using a standard spray gun body configuration. NOTE: ADD -FT FOR FRONT TRIGGER OPTION (NITRO-2 ONLY)

Source Part No.	Gun	Hose Assy.	Fitting	Fitting
NITRO-3	NITRO-1	C4-PU	J44	J44
NITRO-3T	NITRO-1	C4-FEP	MC-F-44	MC-F-44
NITRO-4	NITRO-2	C4-PU	J44	J44
NITRO-4T	NITRO-2	C4-FEP	MC-F-44	MC-F-44

NOTE: ADD -FT FOR FRONT TRIGGER OPTION (NITRO-4 AND NITRO-4T ONLY)

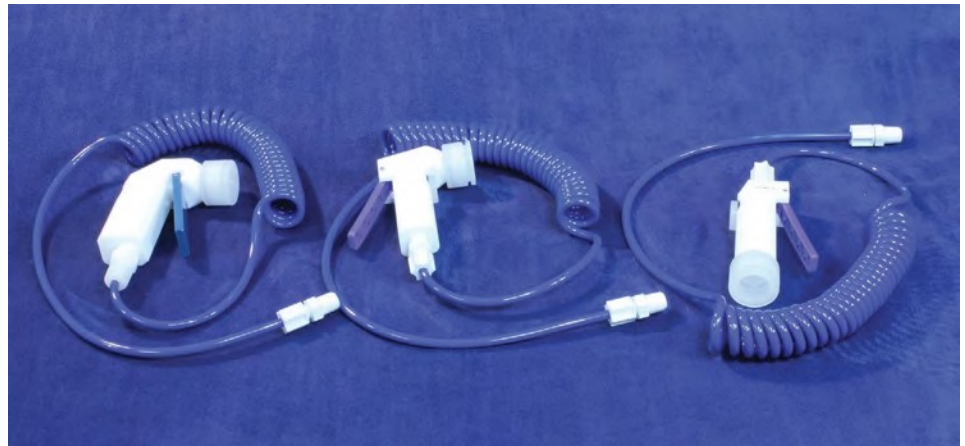

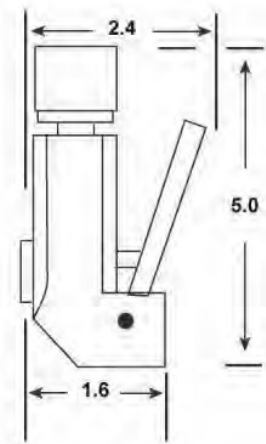

EW-101



EW-30X

EYE WASH

A Qualified Facility Technician should review the installation for the recommended minimum 30 psi water pressure and minimum ANSI Z358.1 flow rate of at least 0.4 gpm for eyewash and 3.0 gpm for eye and face wash. The standard states that the water temperature for flushing eyes should be tepid, between 60°F and 90°F. A full 15 minutes flush of eyes and face are recommended.

Part No.	Description
EW-101	Standard eye wash with 1/4" FNPT inlet thread.

Assemblies Part No.	Gun	Hose Assy.	Intercon. Fitting	Source Fitting
EW-304	EW-101	C6-PU	J64	J64
EW-306	EW-101	C6-PU	J64	J66
EW-308	EW-101	C6-PU	J64	J68



LIQUID DISPENSING GUNS

(Max. operating pressure 75 PSI)

(Media Temperature Range: 40°F – 130°F)

Standard dispensing gun with isolated spring, flow rate 1 GPM. Available in choice of O-ring material: Ethylene Propylene (EP), for use with solvents; Viton (VT), for use with most acids; Kalrez (KA), for use with highly aggressive fluids. To order dispensing gun with the correct O-ring, replace “XX” in the DG part number with the applicable suffix (EP, VT or KA).

Part No.	Description
DG-504-XX	Standard dispensing gun with 1/4" FNPT inlet thread.
DG-506-XX	Standard dispensing gun with 3/8" FNPT inlet thread. ⁽¹⁾
DG-508-XX	Standard dispensing gun with 1/2" FNPT inlet thread. ⁽¹⁾
DG-800-XX	High flow dispense gun. Features the same isolated spring design, but has a flow rate of 3 GPM. 1/2" FNPT inlet thread.

NOTE: ADD -FT FOR FRONT TRIGGER OPTION (DG-50X-XX ONLY)

Assemblies Part No.	Gun	Hose	Intercon. Fitting	Source Fitting
DG-605-XX	DG-508-XX	308	MC-F-88	MC-F-88
DG-606-XX	DG-508-XX	C6-PU	J68	J68
DG-607-XX	DG-506-XX	C6-PU	J66	J66
DG-905-XX	DG-800-XX	308	MC-F-88	MC-F-88
DG-906-XX	DG-800-XX	C6-PU	J68	J68



Special Nozzle Configurations Available

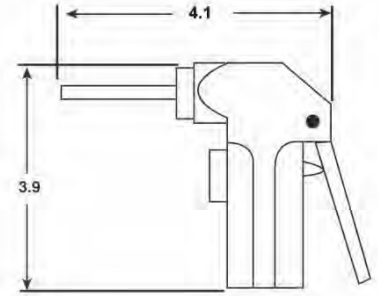

DG-50X-XX

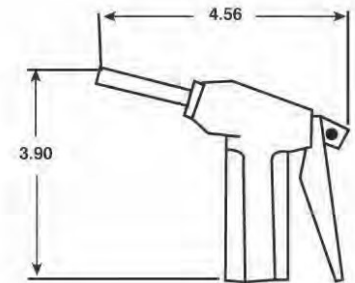

DG-800

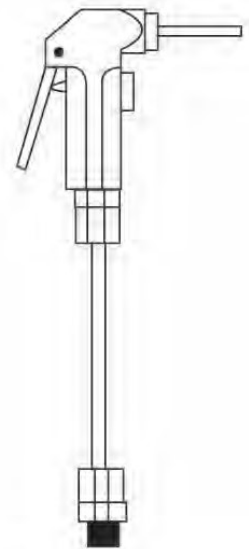

DG-605

Part No.	Reference Description of Assemblies and Spare Parts
304	1/8" ID x 1/4" OD x 8' Long Bendable PTFE Tubing
306	1/4" ID x 3/8" OD x 8' Long Bendable PTFE Tubing
308	3/8" ID x 1/2" OD x 8' Long Bendable PTFE Tubing
C4-FEP	1/4" OD FEP Coiled Tubing ⁽²⁾
C4-FEP-MCF44	C4-FEP Tubing with PTFE Fittings at both ends
C6-FEP	3/8" OD FEP Coiled Tubing ⁽²⁾
C6-FEP-MCF66	C6-FEP Tubing with PTFE Fittings at both ends
C8-FEP	1/2" OD FEP Coiled Tubing ⁽²⁾
C8-FEP-MCF88	C8-FEP Tubing with PTFE Fittings at both ends
C4-PU	1/4" OD Blue Polyurethane Coiled Hose ⁽²⁾
C4-PU-J44	C4-PU Hose with Polypro Fittings at both ends
C6-PU	3/8" OD Blue Polyurethane Coiled Hose ⁽²⁾
C6-PU-J66	C6-PU Hose with Polypro Fittings at both ends
C8-PU	1/2" OD Blue Polyurethane Coiled Hose ⁽²⁾
C8-PU-J88	C8-PU Hose with Polypro Fittings at both ends
C4-PFA	1/4" OD PFA Coiled Tubing ⁽²⁾
C4-PFA-MCF44	C4-PFA Tubing with PTFE Fittings at both ends
C6-PFA	3/8" OD PFA Coiled Tubing ⁽²⁾
C6-PFA-MCF66	C6-PFA Tubing with PTFE Fittings at both ends
C8-PFA	1/2" OD PFA Coiled Tubing ⁽²⁾
C8-PFA-MCF88	C8-PFA Tubing with PTFE Fittings at both ends
RC-3	308 Tubing with PTFE fittings and PTFE recirculating tube
RC-5	C6-FEP Tubing with PTFE fittings and PTFE recirculating tube
RC-7	C6-FEP Tubing with PTFE recirculating tube
RC-9	PTFE source fitting for recirculating spray gun

Part No.	Reference Description of Assemblies and Spare Parts
J44	JACO Male Connector - Polypropylene. 1/4" Tube x 1/4" MNPT
J64	JACO Male Connector - Polypropylene. 3/8" Tube x 1/4" MNPT
J66	JACO Male Connector - Polypropylene. 3/8" Tube x 3/8" MNPT
J68	JACO Male Connector - Polypropylene. 3/8" Tube x 1/2" MNPT
J88	JACO Male Connector - Polypropylene. 1/2" Tube x 1/2" MNPT
MC-F-44	iPolymer Male Connector - PTFE. 1/4" Tube x 1/4" MNPT
MC-F-66	iPolymer Male Connector - PTFE. 3/8" Tube x 3/8" MNPT
MC-F-88	iPolymer Male Connector - PTFE. 1/2" Tube x 1/2" MNPT
900	Nitrogen filter housing
901	Nitrogen filter retaining ring
902	Nitrogen filter O-ring
N2F-10 N2F-50 N2F-100	Disposable nitrogen filters. Each filter is composed of a 25mm diameter Hydrophillic PTFE Membrane 0.80um assembled with Polypropylene Ring with Clear Acrylic Luer Housing. Available in quantities of 10, 50, or 100.
EW-AHA	Eye Wash Aerated Head Assembly. Polypropylene construction complete with screens.

NOTES:

(1) 1/2" Gun Body inlets includes a polypro reinforcing ring.

(2) Coil Stretch Length:

PU will stretch to 7 Feet

FEP will stretch to 6 Feet

PFA will stretch to 6 Feet



(3) Nitro Guns & Eye Wash Guns are OSHA 1910.242(b) and 41-CFR-50-204.8 compliant with their filter and housing attached.

Part #	Relaxed (oal)	Extended	Coil OD
C-4-PU	31"	9'	1-1/8"
C-6-PU	34"	9'	2"
C-8-PU	26"	6'	3-1/2"
C-4-PFA	26"	5' 6"	1-1/2"
C-6-PFA	26"	5' 6"	2-3/8"
C-8-PFA	30"	6' 6"	4"
C-4-FEP	26"	5' 6"	1-1/2"
C-6-FEP	26"	5' 6"	2-3/8"
C-8-FEP	30"	6' 6"	4"

Product Notes:

1. Please email Customer Service at info@pkm-konrad.ch
2. Call us for special applications. We can manufacture our Valves with special mounting and interface dimensions.
3. Upon request, alternate material selection from those listed will allow for expanding temperature ratings or other performance characteristics.
4. Unauthorized disassembly of this product will void the original factory one-year product warranty. For further details please contact us directly.

200304